

# Porkka SD7 Sliding Doors

SD7 200 | SD7 400

Technical datasheet

- Price-quality ratio
- Energy Efficiency
- Engineered safety
- Fast assembly and easy to maintenance
- Improved door control automation
- Decreased lifecycle costs
- Silent and smooth operation
- Wireless applications
- Connectivity
- Clean design





## Porkka SD7 Sliding Doors

Robust, high quality Porkka SD7 sliding doors are designed for demanding applications. They meet the highest safety, quality and hygiene requirements. The models are available both single and double leaf for both cold and freezer rooms.

### Standard features

- Model SD7 200:
  - Door leaf 0-200 kg, drive 0.18 kW
- Model SD7 400:
  - Door leaf 200-400 kg, drive 0.56 kW
- Temperatures -50 ° C to + 60 ° C
- Door surface materials: polyester coated galvanized steel sheet or stainless steel sheet
- Top-rail optimized aluminium profile
- The rail fasteners and door leaf hangers are easy to adjust and install
- Hygienic, user-friendly handles
- Wall Guiding System as standard
- Double gasket material EPDM
- Manual- and Power Operation: in power operated model, automatic and manual open-close function including half-open for pedestrians
- Doubled obstacle detection in power operated doors
- Adjustable speed up to 0.8 m/s and 2-leaf 1.6 m/s
- Frame, type A, 1.25 mm stainless steel
- Frame type B, aluminium
- Wireless accessories

### Accessories

- With versatile accessories, SD7 sliding doors can be customized according to customer's wishes and requirements.
- Mechanical lock
- Electromagnetic Lock
- Floor Guiding System
- Kick plates made of stainless steel or polyethylene
- Collision protection

### Electrical accessories

- Wireless push-buttons and pull rope switches
- Traffic light, radio control
- Induction loop / radar / photocell
- Alarms:
  - moving the door or if the door is open for too long
- Emergency stop buttons



## PORKKA – more than 70 years in the industry

PORKKA cold and freezer room doors are designed and manufactured in a modern Huurre factory in Finland. Huurre has designed and manufactured high quality cold rooms for more than 70 years to satisfied customers around the world.

### Guaranteed hygienic design

SD7 sliding doors comply with the strictest hygiene requirements in the food processing industry. The exterior and interior surfaces are made of smooth polyester coated steel sheets, which means that they are easy to clean. The structure and design of the door have minimized the number of protruding parts, which attract dirt.



### The insulation material is rigid and dense HFC-free polyurethane

Accessories are selected so that they can withstand using also in extreme conditions like very cold freezers. These doors are the ideal choice when you need an indestructible door for heavy-duty use.

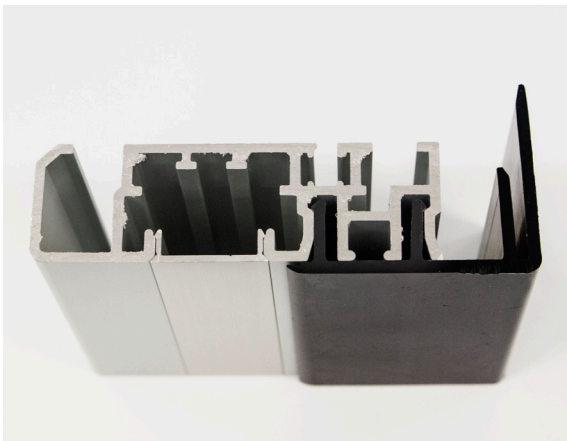

### Functionality and energy efficiency

- Thermal breaks in door leaf and frame
- Double gasket
- Reduced friction between gasket and frame
- Energy-efficient
- Lightened door leaf structure
- Lower need for heating power in freezer doors due to thermal breaks
- Quiet operation
- Double bearings in castor wheels

### Fast and safe

The improved automation on the SD7 sliding doors has many advantages. The acceleration and slowing down phases have a gradual speed control which more than doubles the opening speed. The fast operation means that energy is conserved, as the door remains open for a shorter period. As a result of the better-managed movements, the doors are easy and light to use.

Doubled obstacle detection ensures maximized user safety. Light curtain works as primary safety function and torque sense in electrical motor and automation is always working in background.



### SD7 200 1-leaf, manual operated

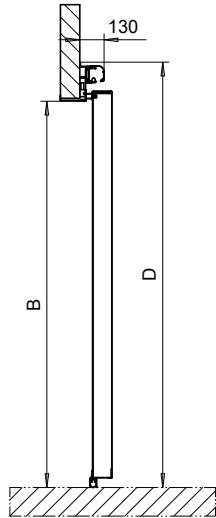
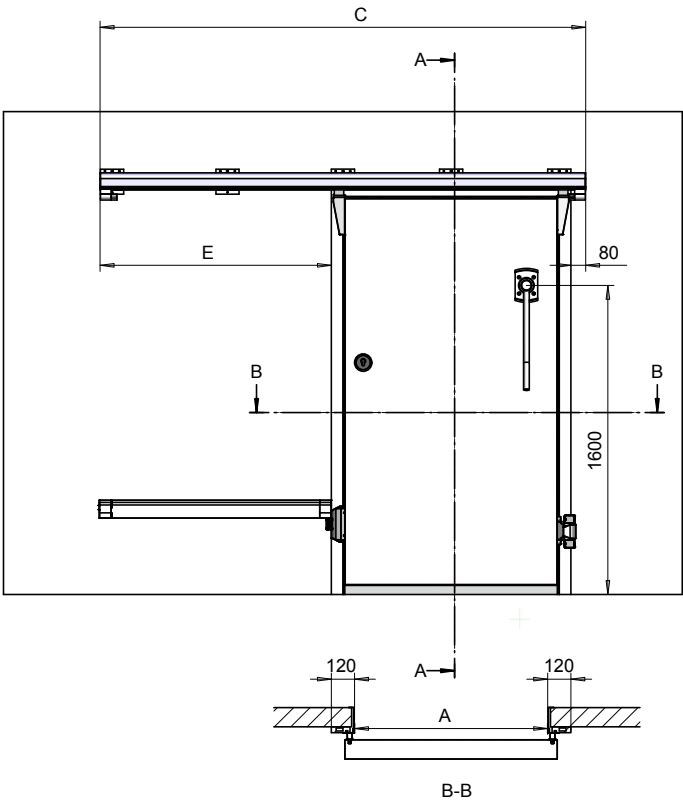

**SD7 200 1-LEAF, MANUAL OPERATED**

DIMENSIONS	DESCRIPTION
A	Clear Opening Width
B	Clear Opening Height
C	$A \times 2 + 520$
D	$B + 202$
E	$A + 200$

215035A

### SD7 200 1-leaf, power operated

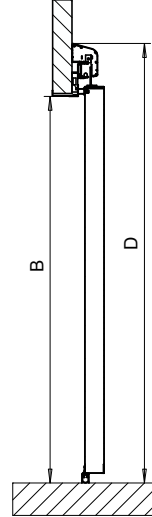
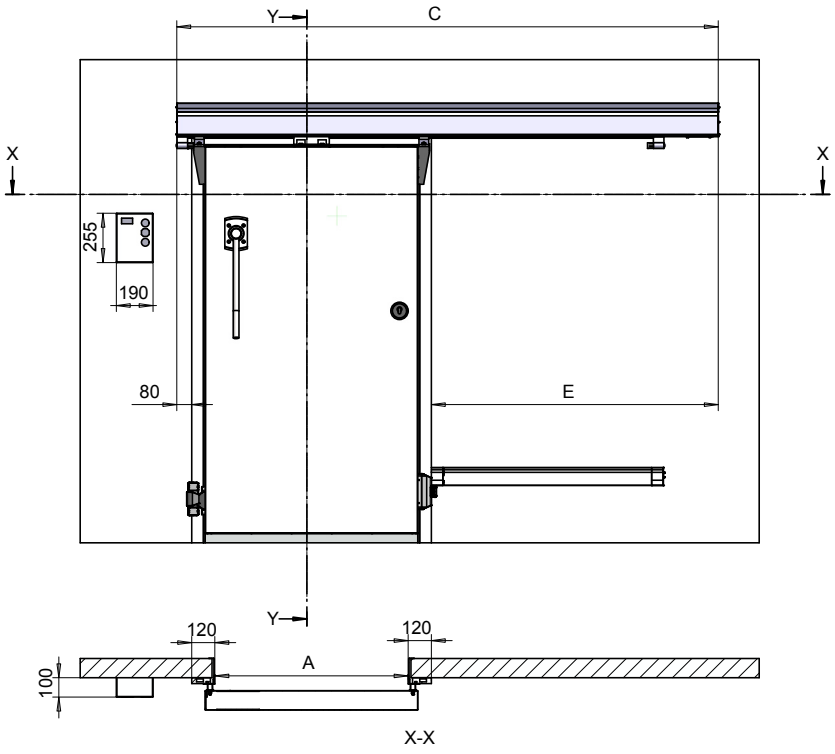

**SD7 200 1-LEAF, POWER OPERATED**

DIMENSIONS	DESCRIPTION
A	Clear Opening Width
B	Clear Opening Height
C	$A \times 2 + 800$
D	$B + 275$
E	$A + 485$

215041A

Note! Electrical motor can be installed into other end of the top-rail also which has affect to the dimensioning

## SD7 200 2-leaf, manual operated

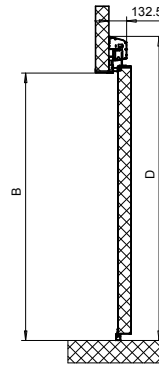
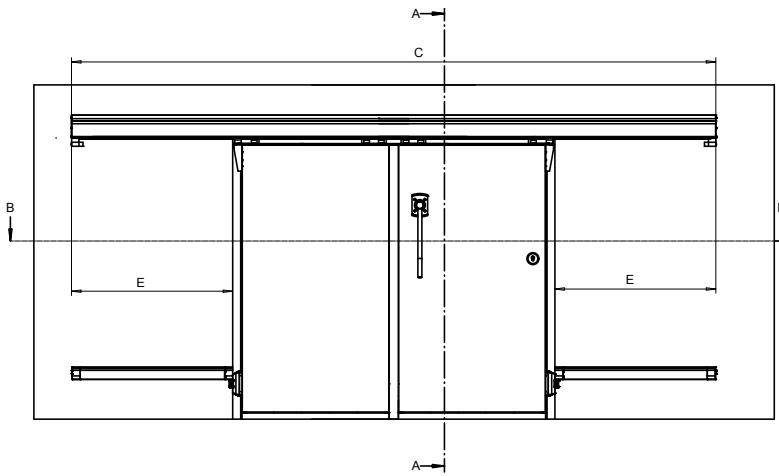

### SD7 200 2-LEAF, MANUAL OPERATED

DIMENSIONS	DESCRIPTION
A	Clear Opening Width
B	Clear Opening Height
C	$A \times 4 + 520$
D	$B + 275$
E	$A / 2 + 120$

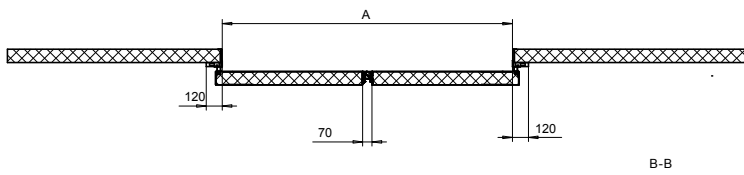

30915

## SD7 200 2-leaf, power operated

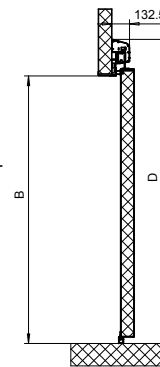
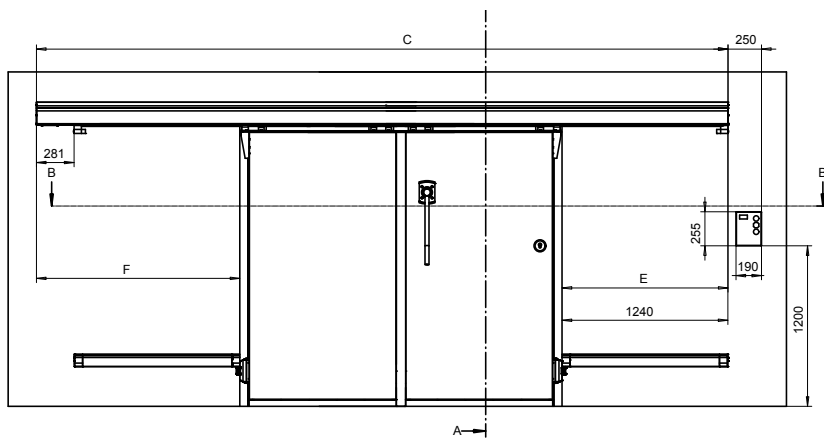

### SD7 200 2-LEAF, POWER OPERATED

DIMENSIONS	DESCRIPTION
A	Clear Opening Width
B	Clear Opening Height
C	$A \times 2 + 800$
D	$B + 275$
E	$A / 2 + 120$
F	$A / 2 + 400$

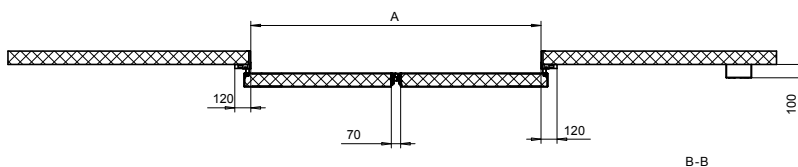

30914

Note! Electrical motor can be installed into other end of the top-rail also which has affect to the dimensioning

### SD7 400 1-leaf, manual operated

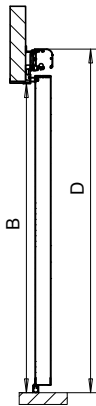
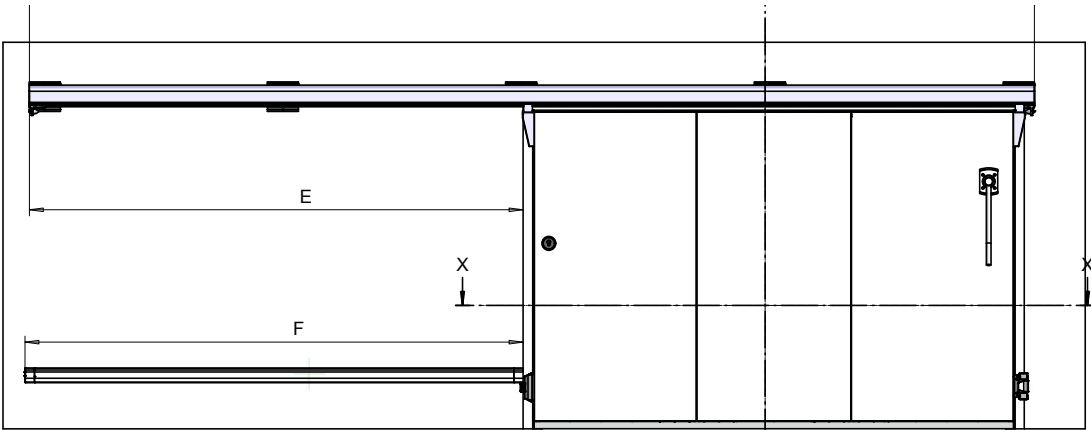

**SD7 400 1-LEAF, MANUAL OPERATED**

DIMENSIONS	DESCRIPTION
A	Clear Opening Width
B	Clear Opening Height
C	$A \times 2 + 500$
D	$B + 235$
E	$A + 195$
F	$A + 222$

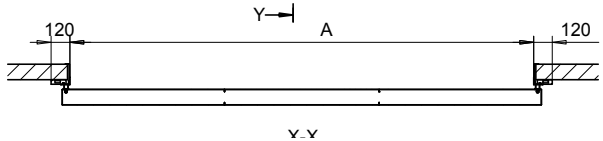

215060A

### SD7 400 1-leaf, power operated

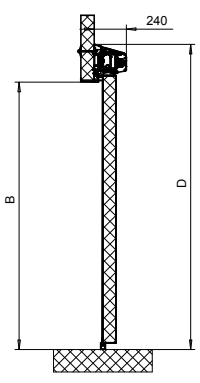
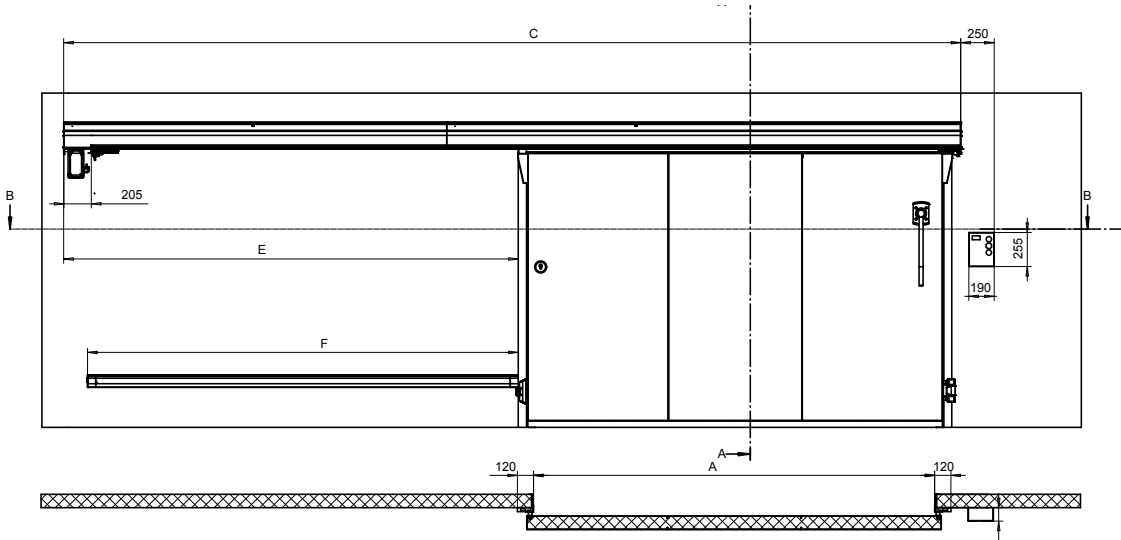

**SD7 400 1-LEAF, POWER OPERATED**

DIMENSIONS	DESCRIPTION
A	Clear Opening Width
B	Clear Opening Height
C	$A \times 2 + 705$
D	$B + 279$
E	$A + 305$
F	$A + 180$

30919

Note! Electrical motor can be installed into other end of the top-rail also which has affect to the dimensioning

## SD7 400 2-leaf, manual operated

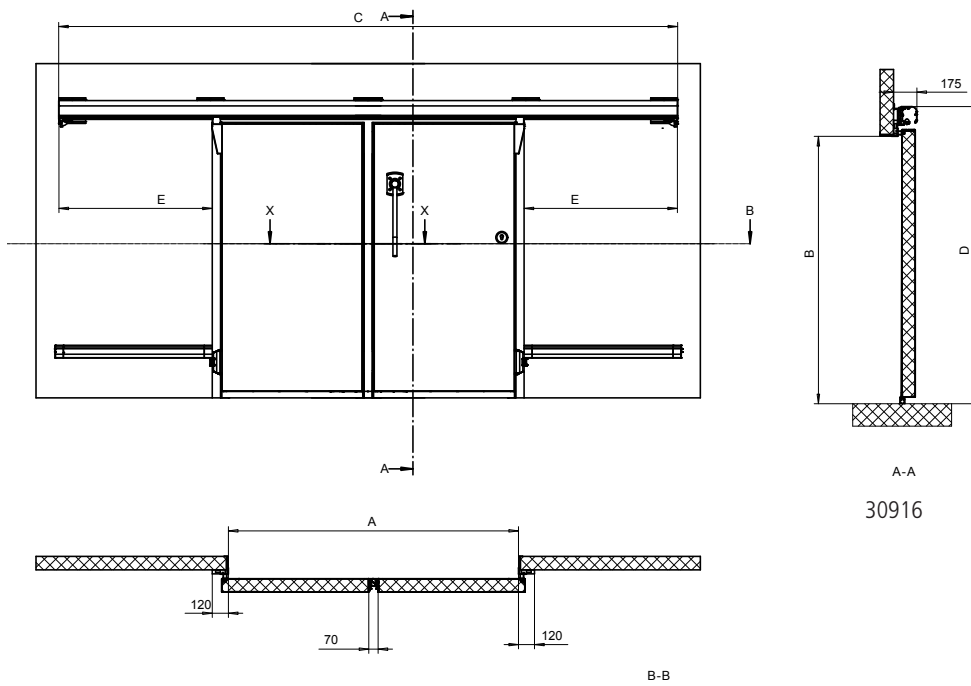

### SD7 400 2-LEAF, MANUAL OPERATED

DIMENSIONS	DESCRIPTION
A	Clear Opening Width
B	Clear Opening Height
C	$A \times 2 + 520$
D	$B + 275$
E	$A / 2 + 140$

30916

## SD7 400 2-leaf, power operated

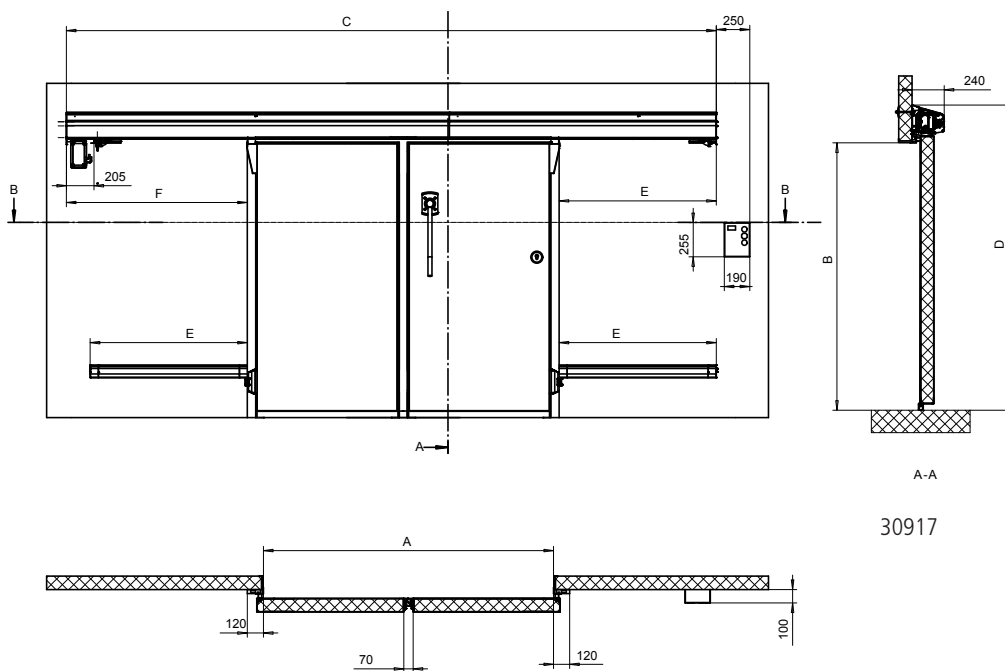

### SD7 400 2-LEAF, POWER OPERATED

DIMENSIONS	DESCRIPTION
A	Clear Opening Width
B	Clear Opening Height
C	$A \times 2 + 725$
D	$B + 279$
E	$A / 2 + 140$
F	$A / 2 + 345$

30917

Note! Electrical motor can be installed into other end of the top-rail also which has affect to the dimensioning

MODELS	SD7 200 1-LEAF	SD7 200 2-LEAFS	SD7 400 1-LEAF	SD7 400 2-LEAF
Door leaf, max. Weight (kg)	0 to 200	100 + 100	200 to 400	200 + 200
Clear Opening Size, Width x Height (mm)	800...2000 x 1800...2500	1500...2000 x 1800...2500	1500...4000 x 1800...4000	1500...4000 x 1800...4000
Drive (kW)	0.18		0.56	
Max. door speed (m/s)	0.8	1.6	0.8	1.6

### GENERAL PROPERTIES

Standard	EN 13241-1: 2003
Handedness	Left or Right
Insulation Thickness (mm)	100 or 150
Temperature Range, Cold Room	+2°C to +60°C (Insulation Thickness 100)
Temperature Range, Freezer	-50°C to +2 °C (Insulation Thickness 150 mm when temperature < - 22°C)
Door Frame Type A	Stainless Steel, installed into wall opening
Door Frame Type B	Aluminium with integrated thermal break and easy access cover profile for the heating cable, installed into surface of the wall

### MATERIALS

Rail and cover	Aluminium, anodized
Door suspension	Plastic wheels with double bearing, aluminium and S/S brackets
Toothed belt	Polyurethan
Door leaf, insulation	HFC free rigid and hard polyurethane
Door leaf, surface	Hot-dip galvanised and polyester coated steel sheet 0.6 mm or Stainless Steel Sheet 0.6-0.8 mm
Door gasket	Double Gasket, EPDM rubber
Sweeper gasket	Double Gasket, EPDM rubber
Middle Gasket (2-leaf doors)	TPE rubber
Door leaf bottom guiding system	Aluminium rail with plastic rollers and roller arm

### ELECTRICS AND AUTOMATION

Mains Supply	230 VAC, 1-phase, 50/60 Hz
Fuse	16 A
Power output max.	1,5 kW
Control Unit dimensions	255 mm x 180 mm x 100 mm
Ingress Protection (EN 60529)	IP66/IP67
Display	45 mm x 27 mm
Cooling	Air cooled
Primary safety function	Light curtain
Secondary safety function	Torque sense
Heating elements in Freezer Room Doors	Heating Cable, 230 VAC, 1-phase, 50/60 Hz, 50 W/m

### ACCESSORIES

Mechanical Lock	Pin lock with open/close sensor
Electromagnetic lock	24 VDC
Wireless pull switch	Battery lifetime 3-5 years
Wireless open close button	Battery lifetime 3-5 years
Traffic lights (wireless option)	24 VDC
Radio Control	1-10 channel
Radar - Vehicle or pedestrian detection	24 VDC
Photo Cell - Vehicle or pedestrian detection	24 VDC
Inductive Loop - Vehicle detection	24 VDC
Alarm	Adjustable timer
Crash barriers	
Floor Guiding System instead of Wall Guiding	



**HURRE**  
VALUE-ADDED REFRIGERATION

Porkka is an internationally recognized designer and manufacturer of professional refrigeration solutions. Key target industries include HoReCa, Medical and Research and Marine. Porkka's products are well known on its long life cycle, high quality and technical advantage.

Porkka is a brand of the Hurre Group. Porkka brand is well known for its quality and reliability throughout the world. The success of Porkka is based on decades of experience,

customer focused design and continuous product development. The materials used in Porkka products are as recyclable and eco-friendly as possible. The recyclability of our product is more than 95%.

Porkka solutions are designed and manufactured according to a quality standard ISO 9001, controlled and certified by Lloyd's Register Quality Assurance. Porkka also holds the environmental certificate ISO 14001, issued also by LRQA.